

Plan 3

Statistics

Area: 129 m²
2 Floors
3 Bedrooms
1 Bathroom

Ground Floor

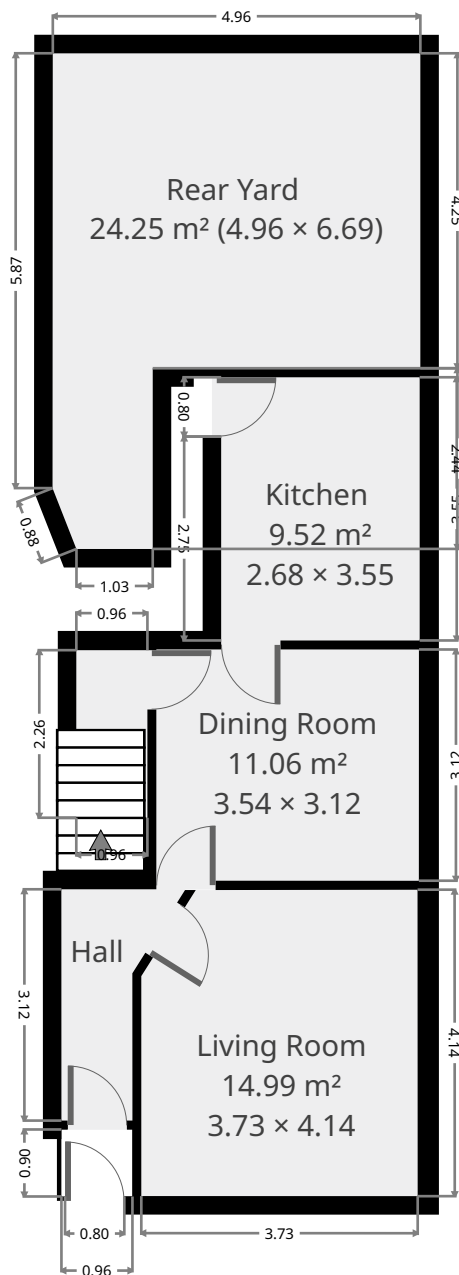

THIS FLOORPLAN IS PROVIDED WITHOUT WARRANTY OF ANY KIND. SENSOPIA DISCLAIMS ANY WARRANTY INCLUDING, WITHOUT LIMITATION, SATISFACTORY QUALITY OR ACCURACY OF DIMENSIONS.

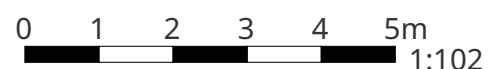

Plan 3

Living Room

Width: 3.73 m
 Length: 4.14 m
 Area: 14.99 m²
 Perimeter: 15.20 m

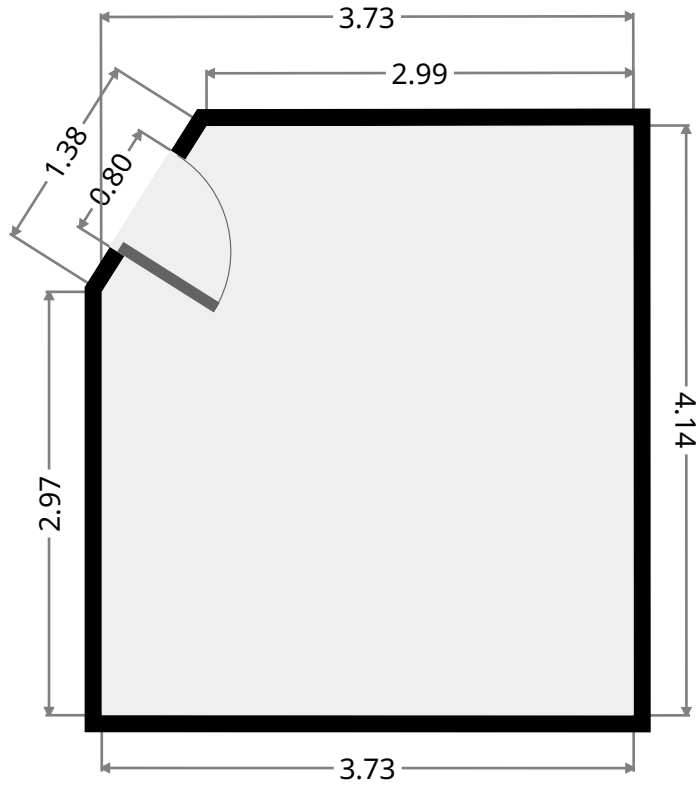
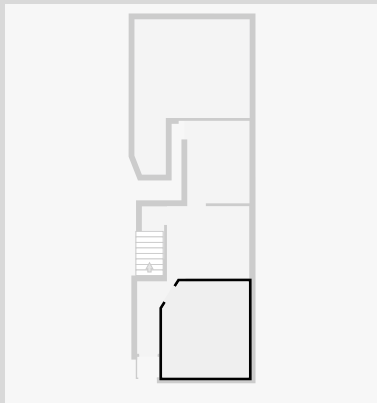

Dining Room

Width: 3.12 m
 Length: 3.54 m
 Area: 11.06 m²
 Perimeter: 13.33 m

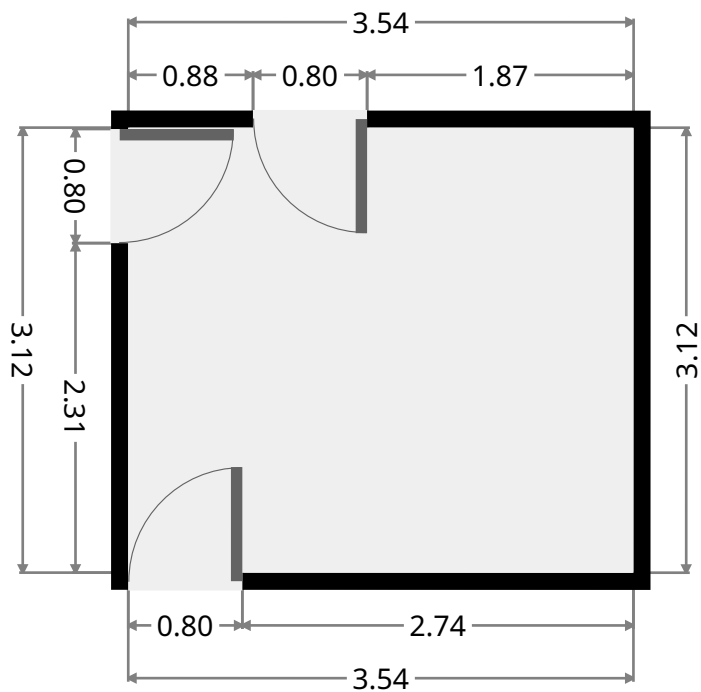
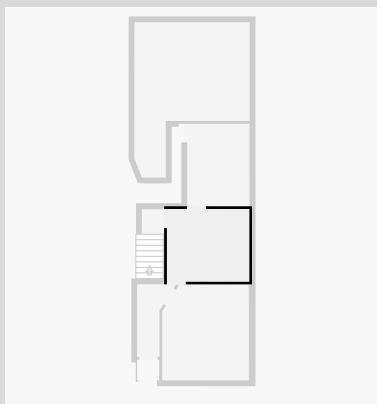

Plan 3

Kitchen

Width: 2.68 m
Length: 3.55 m
Area: 9.52 m²
Perimeter: 12.46 m

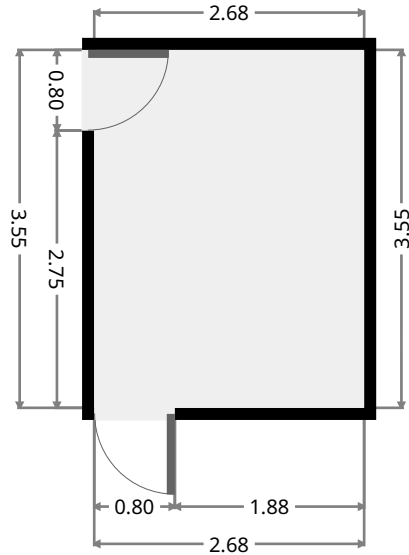
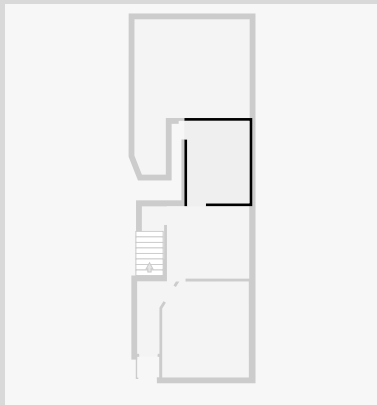

Rear Yard

Width: 4.96 m
Length: 6.69 m
Area: 24.25 m²
Perimeter: 23.04 m

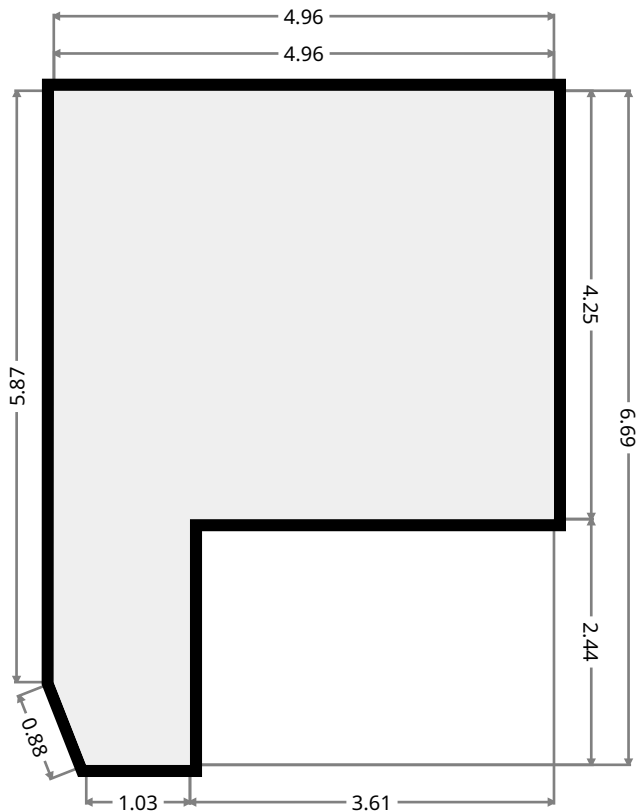
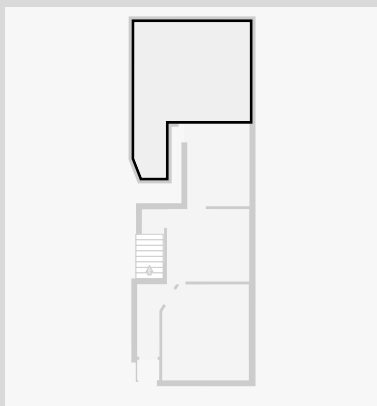

THIS FLOORPLAN IS PROVIDED WITHOUT WARRANTY OF ANY KIND. SENSOPIA DISCLAIMS ANY WARRANTY INCLUDING, WITHOUT LIMITATION, SATISFACTORY QUALITY OR ACCURACY OF DIMENSIONS.



Plan 3

Hall

Width: 1.68 m
Length: 3.12 m
Area: 3.40 m²
Perimeter: 9.08 m

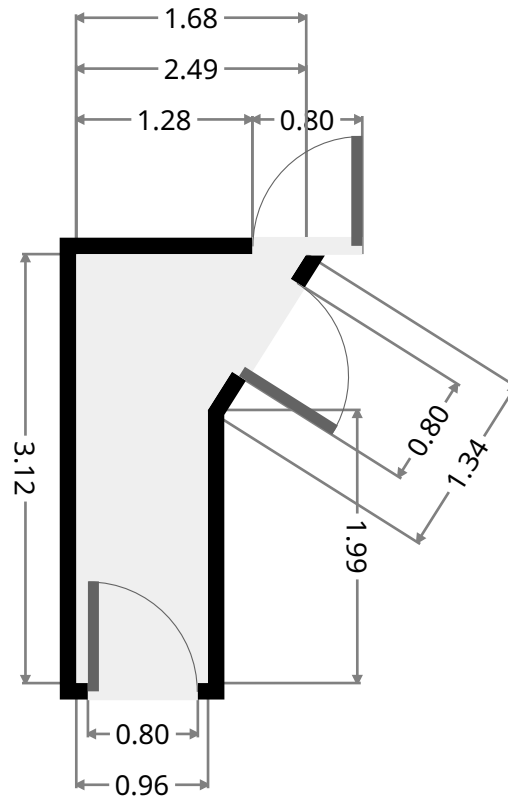
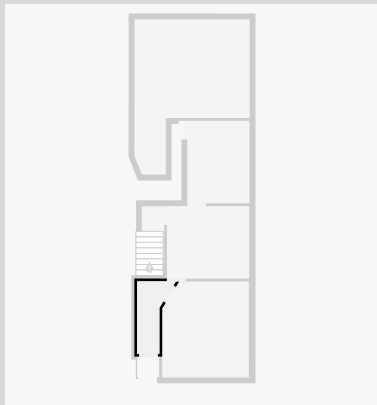

Vestibule

Width: 0.90 m
Length: 0.96 m
Area: 0.87 m²
Perimeter: 3.73 m

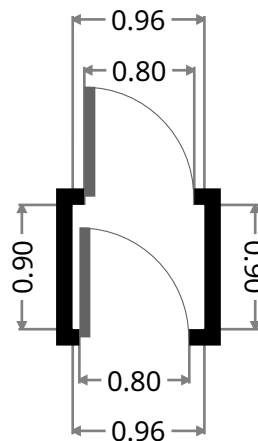
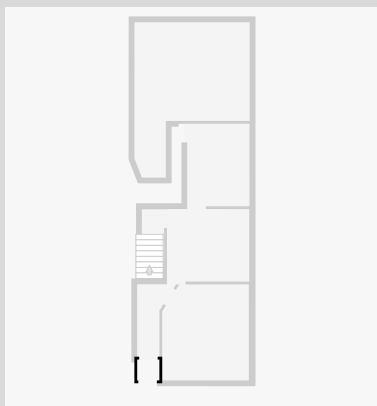

Plan 3

Dinning Storage

Width: 0.96 m
Length: 2.26 m
Area: 2.17 m²
Perimeter: 6.44 m

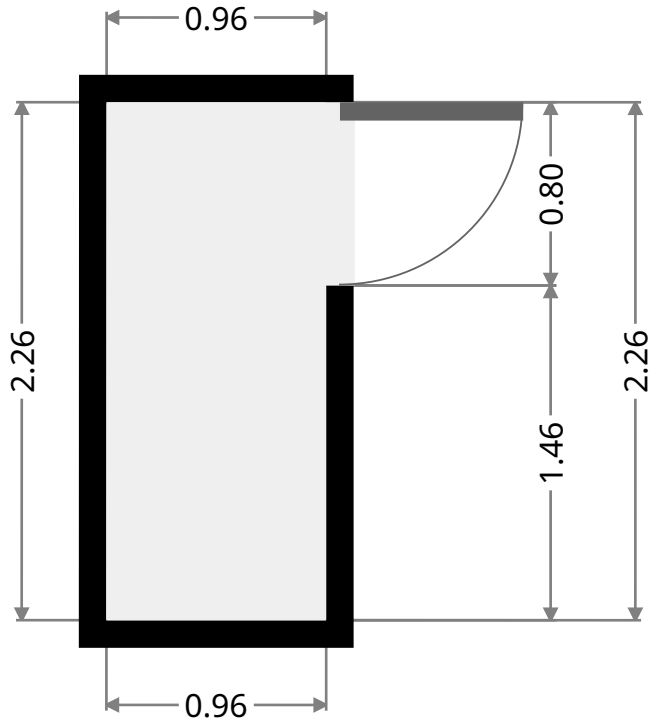
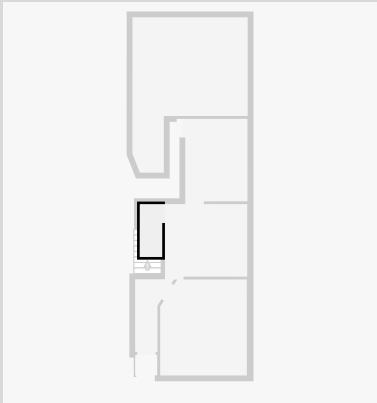

Plan 3

Statistics

Area: 129 m²
2 Floors
3 Bedrooms
1 Bathroom

1st Floor

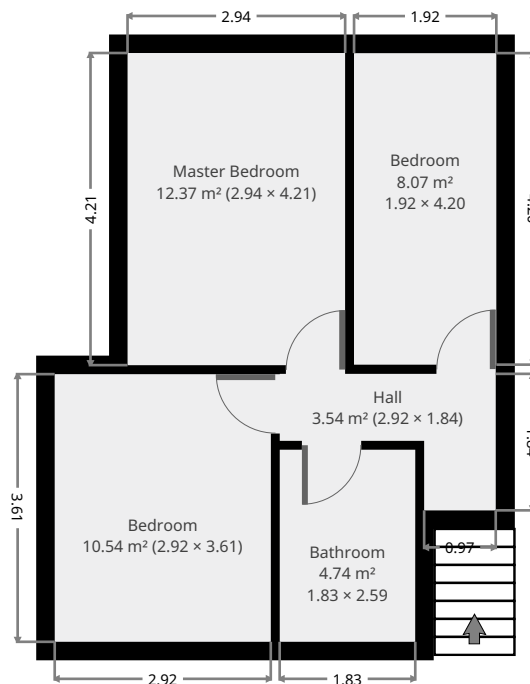

THIS FLOORPLAN IS PROVIDED WITHOUT WARRANTY OF ANY KIND. SENSOPIA DISCLAIMS ANY WARRANTY INCLUDING, WITHOUT LIMITATION, SATISFACTORY QUALITY OR ACCURACY OF DIMENSIONS.

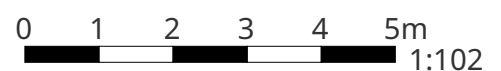

Plan 3

Bathroom

Width: 1.83 m
Length: 2.59 m
Area: 4.74 m²
Perimeter: 8.85 m

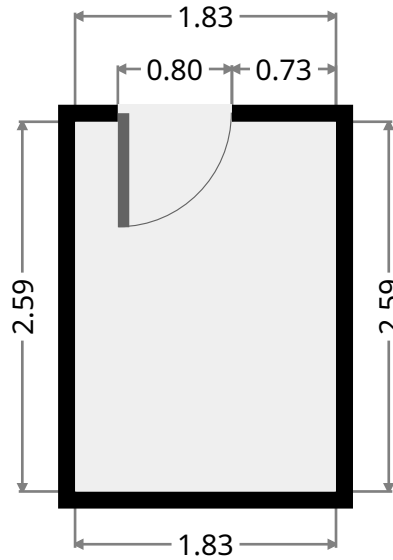
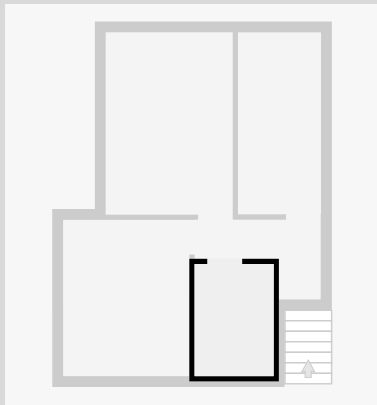

Master Bedroom

Width: 2.94 m
Length: 4.21 m
Area: 12.37 m²
Perimeter: 14.30 m

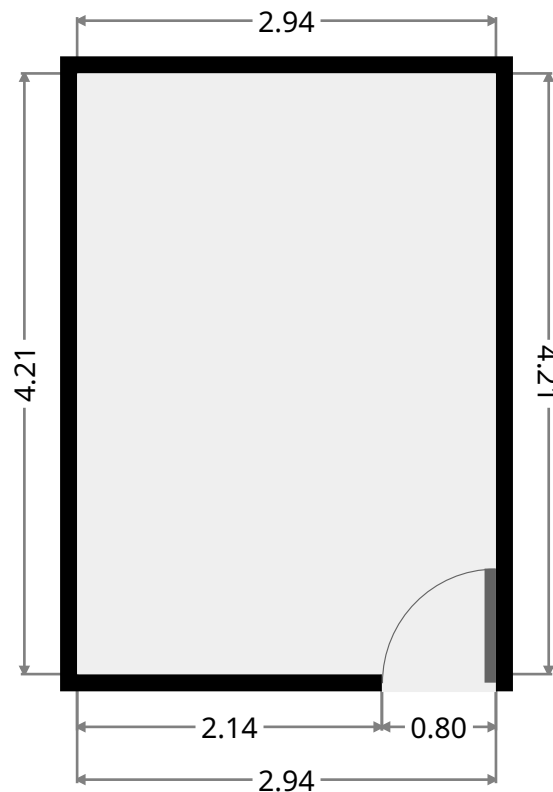
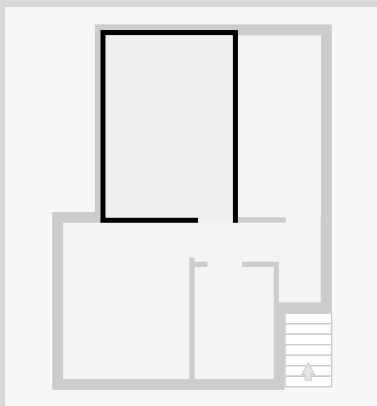

THIS FLOORPLAN IS PROVIDED WITHOUT WARRANTY OF ANY KIND. SENSOPIA DISCLAIMS ANY WARRANTY INCLUDING, WITHOUT LIMITATION, SATISFACTORY QUALITY OR ACCURACY OF DIMENSIONS.

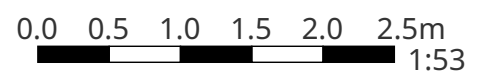

Plan 3

Bedroom

Width: 2.92 m
Length: 3.61 m
Area: 10.54 m²
Perimeter: 13.06 m

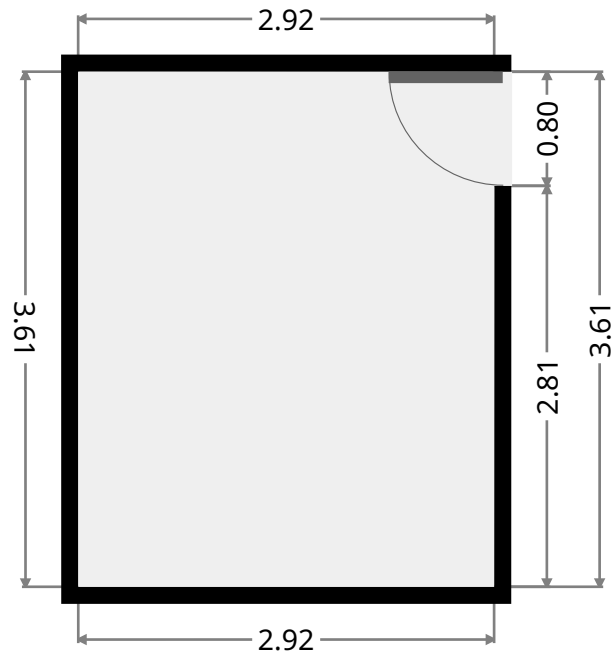
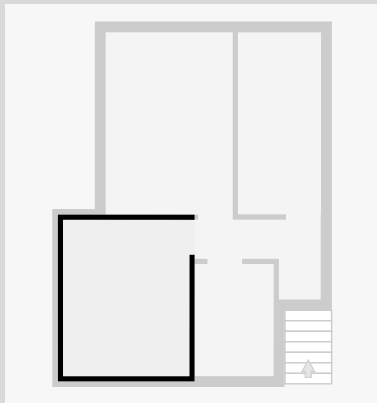

Bedroom

Width: 1.92 m
Length: 4.20 m
Area: 8.07 m²
Perimeter: 12.25 m

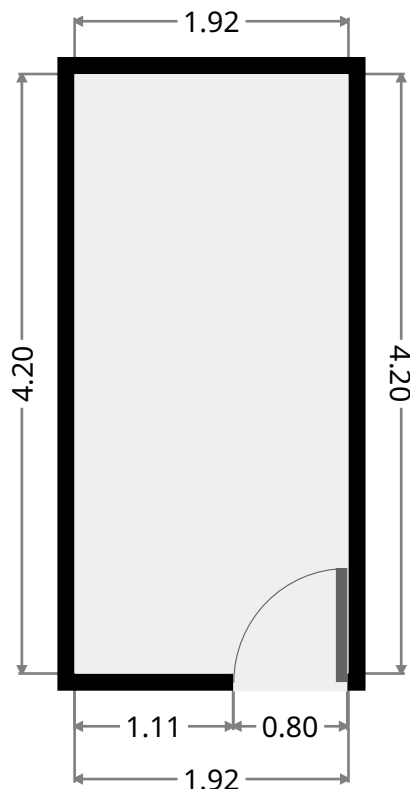
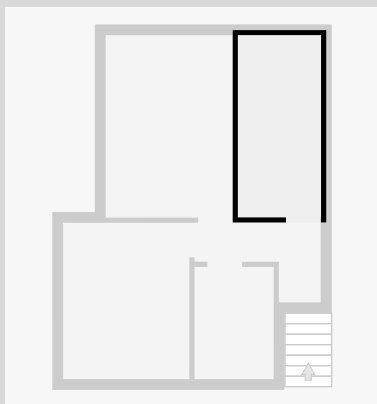

Plan 3

Hall

Width: 1.84 m
Length: 2.92 m
Area: 3.54 m²
Perimeter: 9.52 m

